

NOTE: First install peg hooks into pegboard prior to installing the Gondola Upright Security Bar, one level at a time.

NOTE: Install working from bottom to top and from left to right.

Tools Needed:
 • Phillips Screwdriver
 • Wrench

- ① Slide all Panels into lower track of the Rail.

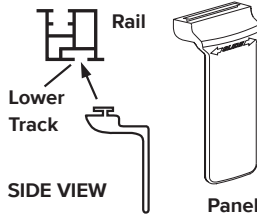

- ② Insert an Installation Pin into the Flipper Nut™ in the aligning hole.

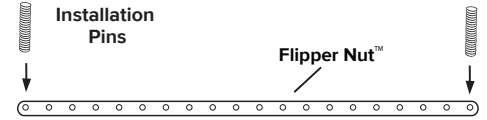

- ③ Slide Flipper Nut™ with Installation Pins into top track of the Rail.

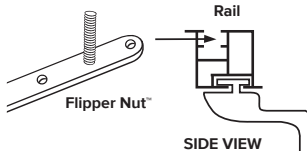

- ④ Align Installation Pins in the Flipper Nut™ to the holes in the Gondola Upright Security Bar.

NOTE: Flipper Nut™ slide easily in the track. Keep Rail level at all times to maintain Flipper Nut™ position.

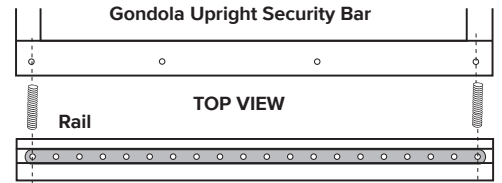

- ⑤ Place the Rail under the Security Bar. Align Installation Pins with the holes along the top of the Security Bar.

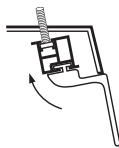

- ⑥ Push Installation Pins through the holes and hold the Rail flush against the bottom of the Security Bar. **NOTE:** For balance, it is best to hold the rail at the center.

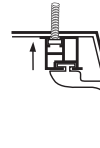

- ⑦ Insert Screws into the center two holes along the top of the Security Bar and screw into Flipper Nut™. Unscrew Installation Pins. Insert Screws into holes and screw into Flipper Nut™.

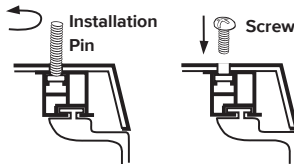

- ⑧ Working from the bottom of planogram, install assembled Security Bar into slots of the gondola uprights. Engage both Locking Levers into the gondola upright slot and tighten wingnuts.

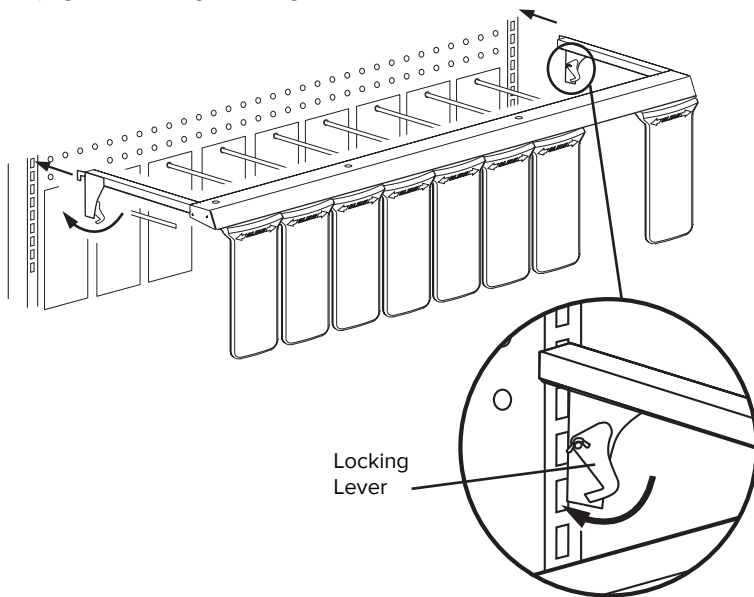

- ⑨ Repeat steps 1-8 and install another Security Bar above the one just installed.

- ⑩ Moving upward, continue installing Security Bars. Installation is complete.

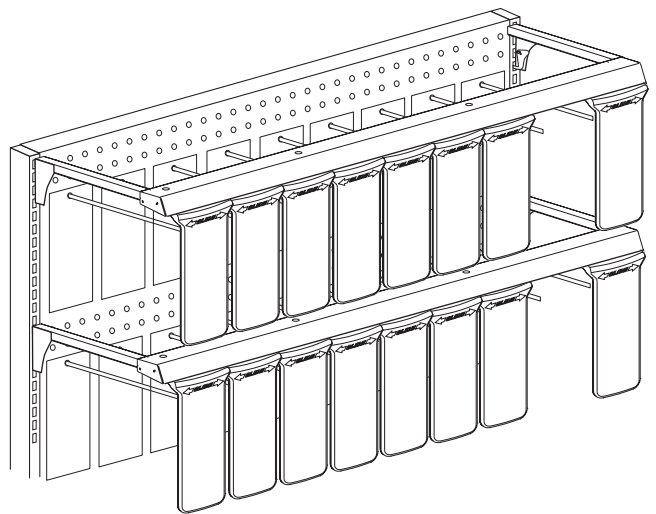

20190516